

NM100/NC300 SERIES OPERATING MANUAL

READ AND SAVE THESE INSTRUCTIONS

CAUTION

TO REDUCE THE RISK OF FIRE, ELECTRIC SHOCK, OR INJURY TO PERSONS, OBSERVE THE FOLLOWING:

1. Read all instructions carefully before installing or using the NM100/NC300 System.
2. The NM100/NC300 must be installed by a qualified dealer or installer, and must conform to all local building and electrical codes.
3. Adhere to all warnings on the NM100/NC300 and in these instructions. Follow all operating and installation instructions.

WARNING



- Do not expose the NM100/NC300 to moisture. Doing so can create fire or shock hazards and void the warranty.
- Do not attempt to service this product yourself as opening or removing covers may expose you to dangerous voltage or other hazards and will void your warranty. Neither the Master Station nor the Room/Patio Stations contain any user-serviceable parts. REFER ALL SERVICING TO QUALIFIED SERVICE PERSONNEL.

The lightning flash with arrowhead symbol within an equilateral triangle is intended to alert the user to the presence of uninsulated “dangerous voltage” within the product’s enclosure that may be of sufficient magnitude to constitute a risk of shock to persons.

The exclamation point within an equilateral triangle is intended to alert the user to the presence of important operating and maintenance (servicing) instructions in the literature accompanying the product.

- Use only NuTone replacement parts and have them installed by a NuTone dealer or installer. Unauthorized substitutions can result in fire, electric shock, or other hazards.
- Upon completion of any service or product repair, have the NuTone dealer or installer conduct a safety check to ensure the system is in proper operating condition.
- Use only a damp cloth to clean the Master Station, Remote Stations, Door Stations, and speakers. Do not use liquid cleaners or aerosol cleaners.

SYSTEM OVERVIEW

The NM100 is an intercom and sound system designed for today’s home. Its compact size and modern, elegant look complement any décor. The NM100 offers more than just sensible good looks. It gives you peace of mind as it allows you to communicate with family members and monitor specified rooms. The NM100 offers high quality sound throughout your home from several sources, including the radio, CD player or other connected audio sources in your home.

Please read all of the safety instructions before changing any settings on your NM100.

Keep this manual in a safe place for future reference. If you lose the manual, you can download it from the NuTone web site (www.nutone.com).

The NM100 is a retrofit system designed to use your existing intercom wiring and consists of three major components:

- Master Station
- Indoor/Outdoor Remote Station—You can install up to 9 Remote Stations in individual zones, 15 Remote Stations in shared zones on a 4-wire (M&S Systems retrofit) installation and 13 Remote Stations in shared zones on a 3-wire (NuTone retrofit), including 2 Outdoor Remote Stations.
- Door Station—You can install up to 3 Door Stations.

MASTER STATION

The Master Station gives you control over the system intercom and music capabilities. System setup is established at the master. These settings include: set the clock and establish music auto on/off times, select the system music source, save preset radio stations and set the scan mode. System volume, loudness, treble and bass can also be controlled from the NM100 master. Intercom functionality for each Remote Station is established at the master by setting the intercom selector switches. Each remote station can be set to Intercom Only, Radio and Intercom, Off, or Monitor.

The NM100 provides the ability to monitor other stations and communicate with Door Stations. System functionality can also be established to provide Security and Home Automation features.

INDOOR/OUTDOOR REMOTE STATIONS

The Remote Stations provide intercom functions and system music control capabilities. Depending on the room configuration at the Master Station, a remote station can communicate with or monitor other stations and communicate with the Door Stations. The system’s music can be turned on and off, music volume adjusted, and music sources changed from the remote stations.

DOOR STATION

The Door Station is an exterior intercom speaker and door chime pushbutton installed at home entrances. The NM100 system supports up to 3 door stations. The door station allows for communications from within the house to visitors. Any station with its Intercom Selector Switches set to Intercom or Radio/INT can communicate with the Door Station.

SYSTEM SETTINGS

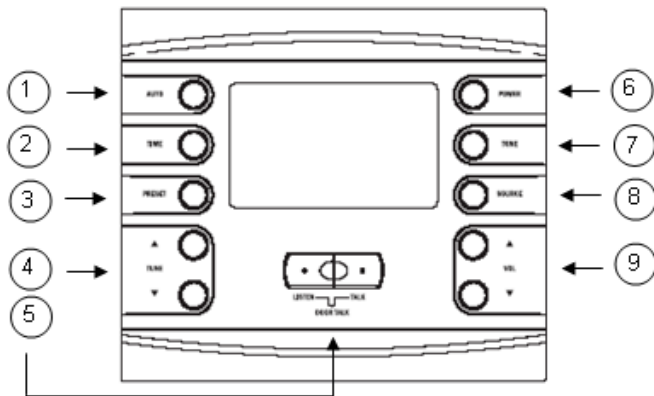

- ① AUTO - Enable or disable Music Auto
- ② TIME - Set clock and Music Auto On/Off
- ③ PRESET - Preset radio stations
- ④ TUNE - AM/FM Tune radio
- ⑤ DOOR TALK / LISTEN / TALK - Intercom Talk + Listen
- ⑥ POWER - Turn system music On/Off
- ⑦ TONE - Select volume and tone settings
- ⑧ SOURCE - Select music source
- ⑨ VOL - Change volume, tone and time settings

CLOCK SETTINGS

You can set two clock functions:

- Normal—Displays the normal time of day.
- Music Auto On/Off—Sets the times to automatically turn the last music source on and then off.

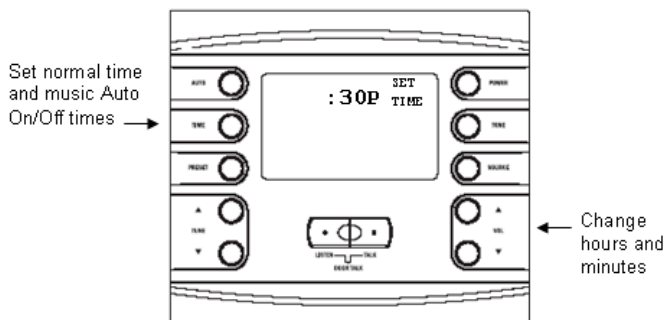

To change clock settings:

1. Press TIME. The hour field for Normal Time blinks, and SET TIME appears on the display.
2. Press VOLUME UP or VOLUME DOWN to change the hour. An A or P indicates AM or PM, respectively.
3. Press TIME. The minute field blinks. Use the VOLUME buttons to change the minutes.
4. Press TIME to continue through the settings: Music Auto On, hour and minutes and Music Auto Off, hour and minutes.
5. After you have entered Music Auto Off minutes, press TIME to return to Normal Time display.

Note: You can enable or disable the AUTO function. The word "Auto" will appear on the display when Auto Function is on. See Music Settings/Auto On/Off.

MUSIC SETTINGS

Music Source

You can select from four music sources:

- AUX—Any audio source you connect, such as an external CD player or a stereo system.
- AM radio
- FM radio
- CD player (NC300WH CD Player). This source can also be used to hook up an external audio device if the system does not include an NC300 CD player. For CD functionality, see Master Station Operation/CD Player Operation.

To select a music source:

1. Press POWER to turn on music.
2. Press SOURCE repeatedly to cycle through AUX, AM, FM, and CD until you reach the music source you prefer.

Music Auto On/Off

You can set the system to turn music on automatically at a predetermined time and to turn the music off automatically at a predetermined time.

1. Set the Auto On/Off times as described under Clock Settings.
2. Press the AUTO button to toggle between On and Off. When the Auto function is on, AUTO appears on the display.

RADIO SETTINGS

You can tune in FM or AM radio stations, and can set up to 8 presets on each band.

Tune the Radio

To tune a radio station:

1. Press POWER to turn on the music.
2. Select FM or AM. See Music Settings/Music Source for instructions.
3. Use TUNE UP or TUNE DOWN to find a station. If you press and release, within 1 second, TUNE UP or TUNE DOWN, the tuner goes into Seek Mode and finds the next station with a strong signal. If you press and hold TUNE UP or TUNE DOWN, the tuner goes into Scan Mode and scans all frequencies until you release the button.

Note: For the first two seconds, the tuner scans at slow speed to allow for fine tuning. After two seconds, the tuner scans at fast speed.

Preset Radio Stations

To preset radio stations:

1. Press POWER to turn on the music.
2. Select FM or AM. See Music Settings/Music Source for instructions.
3. Use TUNE UP or TUNE DOWN to find a station. See Tune the Radio section for seek and scan functions.
4. Simultaneously press TUNE UP and TUNE DOWN to enter Store Preset mode. The display shows PRESET and a preset number.

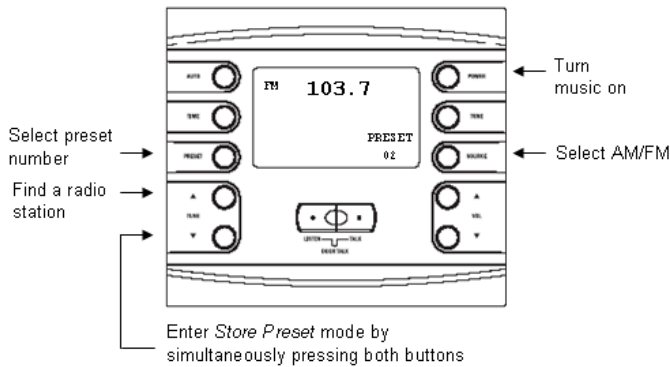

5. If you don't want to assign a preset number, wait 5 seconds and your selected radio station will automatically be assigned to the preset number that is displayed. If you want to select the preset number, press the PRESET button repeatedly to cycle through numbers 1-8 until you reach the preset number you want.
6. Wait 5 seconds. The display updates to show the new station for the selected preset number.

Note: This activity can be cancelled at any time during the process by pressing TUNE UP and TUNE DOWN simultaneously again, and no new preset is stored.

Scan Mode

Two scan modes are available. The scan mode for the room stations is set at the master. The two scan modes are identified in the next figure. To set your scan mode:

- Scan 1—Allows the Indoor/Outdoor Remote stations to scan through the four music sources (AUX, AM, FM, CD). On radio bands AM and FM, Scan 1 scans through the preset radio stations: AM 1-8 and FM 1-8. See Music Settings/Radio Settings for information on how to preset radio stations.
- Scan 2—Allows Indoor/Outdoor remote stations to scan through the four music sources (AUX, AM, FM, CD.) On radio bands AM and FM, Scan 2 scans all strong stations before moving on to the next source.

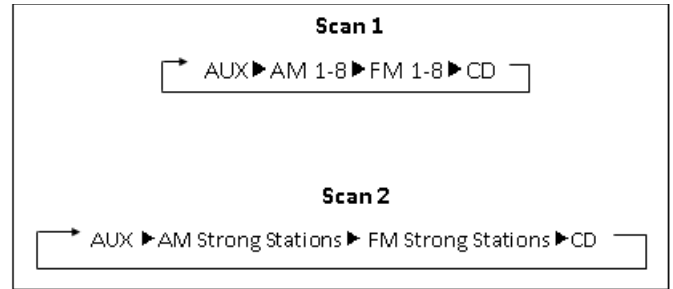

To set the Scan Mode:

To change the scan mode, simultaneously press and release PRESET and SOURCE again. The display shows either Scan1 or Scan2.

Note: Exit out of scan mode by pressing PRESET and SOURCE or waiting for the display to show the clock time again.

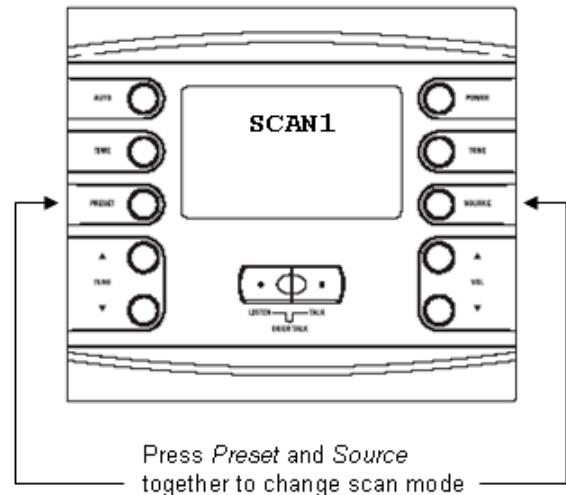

AUDIO SETTINGS

Volume

- Music—Adjusts the volume for system music.
- Master Station—Adjusts the volume for the speaker on the Master Station only.
- Intercom—Adjusts the volume for the system intercom.

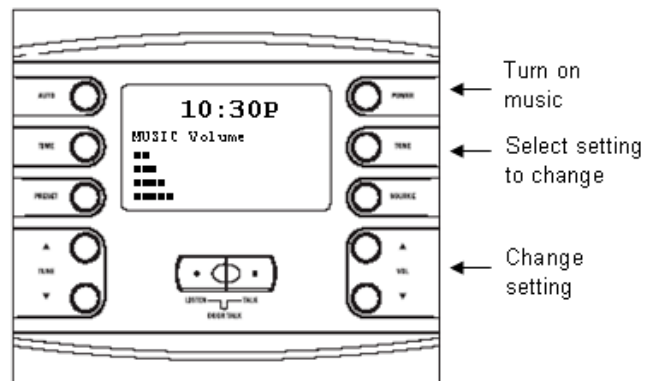

MUSIC VOLUME EXAMPLE

Tone

- Loudness
- Treble
- Bass

To change volume and tone settings:

1. Press POWER to turn on music. The system defaults to music volume. Use VOLUME UP and VOLUME DOWN to adjust the music volume from 0-29. All other audio settings return to music volume after 5 seconds.
2. Press TONE. Master Volume appears. This controls the volume for the Master Station speaker only. Use VOLUME UP and VOLUME DOWN to adjust the Master Volume from 0-29.
 Note: When music is off, use VOLUME UP and VOLUME DOWN to adjust Master Volume.
3. Press TONE. The Loudness function appears. Press VOLUME UP to turn Loudness on. Press VOLUME DOWN to turn Loudness off.
4. Press TONE. The Treble function appears. Use VOLUME UP and VOLUME DOWN to adjust the treble from 0-14.
5. Press TONE. The Bass function appears. Use VOLUME UP and VOLUME DOWN to adjust the bass from 0-14.
6. Press TONE. Intercom Volume appears. Use VOLUME UP and VOLUME DOWN to adjust the Intercom Volume from 0-29.

Note: When music is off, press TONE to access Intercom Volume, then use VOLUME UP or VOLUME DOWN to adjust Intercom Volume.

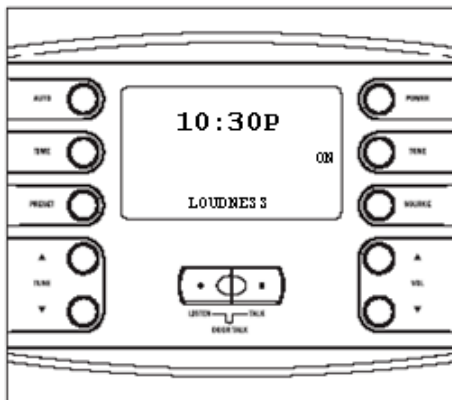

LOUDNESS TONE EXAMPLE

DISPLAY BRIGHTNESS

1. Simultaneously press TUNE UP and POWER. The display cycles through brightness levels: low, medium, and high, then repeats the cycle.
2. Press the buttons repeatedly until you reach the brightness you prefer.

INTERCOM SELECTOR SWITCH SETTINGS

You can set all major Intercom functions using the Intercom selector switches on the Master Station.

You can set each station to one of four configurations:

- Intercom Only
- Radio/INT (Music source and Intercom)
- Off
- Monitor

Note: When the system has more than 9 Room Stations some intercom selector switches will control two room stations.

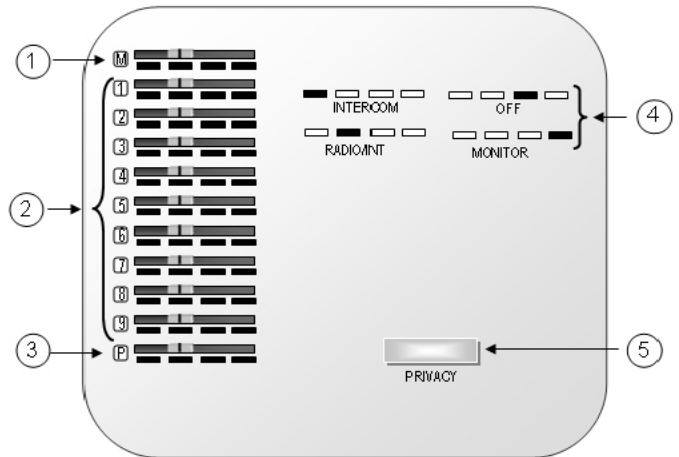

- ① Selector switch for Master Station
- ② Selector switches for Remote Stations
- ③ Selector switch for Outdoor/Patio Remote Station
- ④ Key to Intercom selector switch settings
- ⑤ Privacy button

Intercom

When a station is set to Intercom (Intercom only):

- You can talk and listen from this station.
- The room does not receive music.
- The room cannot be monitored.
- The room cannot hear other rooms that are set to Monitor.

Note: When a station is set to Intercom, the sound and activity in that room can be heard by another remote station by pressing the LISTEN button.

- The station hears the door chime and users can talk and listen to the Door Station.

Radio and Intercom

When a station is set to Radio/INT (Music source and Intercom):

- You can talk and listen from this station.
- The room can receive music.
- The station can monitor any other station that is set to Monitor.

Note: When music is on, the audio from a monitored room is heard in addition to the music.

- The station itself cannot be monitored.

Note: When a station is set to Radio/INT, the sound and activity in that room can be heard by another remote station by pressing the LISTEN button.

- The station hears the door chime and communicates with and listens to a Door Station.

Off

When a station is set to OFF:

- You can communicate from an Indoor Remote Station but you cannot communicate from an Outdoor Remote Station.
- Other Remote Stations cannot listen to the room.
- The room cannot receive music or intercom-related audio.
- The room cannot be monitored.
- The station does not hear the door chime and cannot talk and listen to the Door Station.

Monitor

When a station is set to Monitor:

- Any station set to Radio/INT can continually hear all sound and activity in the room.
- You can communicate with other room stations.
- The room cannot hear the door chime.
- You can talk to the Door Station, but will not be able to listen to it.
- The room cannot receive music.

INTERCOM OPERATION

TALK

Talk allows users to talk to all stations with selector switches set to Intercom or Radio/INT.

To initiate a Talk/Listen session, press TALK and begin talking. You can hear remote users if you press the LISTEN button or if they press their TALK button.

LISTEN

Press LISTEN to listen to all stations set to Intercom or Radio/INT.

DOOR TALK/LISTEN

- Press TALK and LISTEN simultaneously to enter Door Talk mode. This allows you to talk to the Door Stations. All other stations set to Intercom or Radio/INT can hear the conversation.
- Release the TALK and LISTEN buttons to listen to the Door Station. The Listen mode is active for a total of 25 seconds after you release the TALK and LISTEN buttons. You may talk again at any time by pressing TALK and LISTEN. Each time the buttons are released, you can listen for another 25 seconds.
- Door Talk mode is suspended at the end of the 25 second listening period or if you press either the TALK button or the LISTEN button individually.

MONITOR

All stations set to Radio/INT on the Master Station can continually hear the sound and activity from a station set to Monitor.

SECURITY/HOME AUTOMATION (OPTIONAL)

This optional function can control another system that is properly connected to the NM100. For example, it may control a door release mechanism, turn on the lights, set off an alarm, etc. This function is available from the Master Station and Remote Stations (NRS103WH and NRS104WH). It is not available from an outdoor remote station.

To initiate this feature from a room station:

1. Simultaneously press VOLUME UP and VOLUME DOWN and hold for at least 4 seconds. After 4 seconds, this feature is active for as long as the buttons are pressed.
2. Release the buttons to deactivate the feature.

MASTER STATION OPERATION

Radio Operation

1. Press POWER to turn on music.
2. Select either FM or AM as the music source. See Master Station Settings/Music Settings/Music Source for instructions.
3. Use TUNE UP or TUNE DOWN to select a station, or press PRESET to select a preset station.

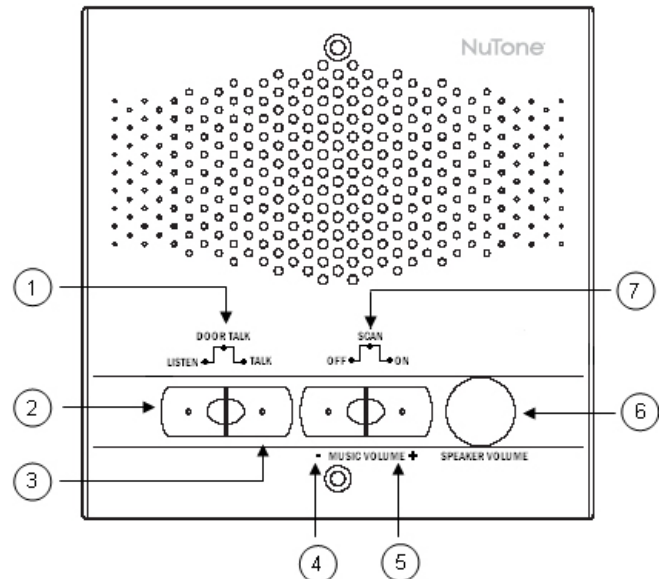

- ① Door Talk (Talk + Listen)
- ② Listen
- ③ Talk
- ④ Music Volume Down
- ⑤ Music Volume Up
- ⑥ Speaker Volume
- ⑦ Scan (Select Music Source)

REMOTE STATION OPERATION 4-WIRE (M&S SYSTEMS RETROFIT)

Remote Station Functions

- Door Talk/Listen
Press TALK and LISTEN simultaneously to talk to the Door Stations. Release both buttons to listen.
- Listen
Listen to all stations set to Intercom or Radio/INT.

- Talk
Talk to all remote stations set to Intercom or Radio/INT.
- Speaker Volume
Use Speaker Volume knob to adjust the remote speaker volume.
- Music Volume

Turn Music Source On and Off

You can turn the Music Source on and off from the NRS104WH or the NPS104WH Remote Station.

To turn the Music Source on, press and hold the MUSIC VOLUME UP button.

To turn the Music Source off, press and hold the MUSIC VOLUME DOWN button until the volume level goes to zero.

Adjust System Music Volume

Adjust the system music volume from any Remote Station by pressing VOLUME UP or VOLUME DOWN.

- **Select Music Source**

The system music source can be selected from any Remote Station. The music sources that are available vary depending on the Scan setting on the Master Station (See Master Station Settings/Music Settings/Scan Mode for details).

Note: You cannot select specific tracks on the CD from a Remote Station.

To scan for a music source:

Simultaneously press and release VOLUME UP and VOLUME DOWN to switch music sources.

REMOTE STATION OPERATION 3-WIRE (NUTONE RETROFITS)

Remote Station Functions

- Door
Press Door to talk to the Door Station. Release button to listen to the Door Station.
- Remote
Press Remote to talk to Remote Stations. Remote Stations press Talk to reply.
- Speaker Volume
Use Speaker Volume knob to adjust the remote speaker volume.
- Music Volume

Turn Music Source On and Off

You can turn the Music Source on and off from the Remote Station.

To turn the Music Source on, press and hold the MUSIC VOLUME UP button.

To turn the Music Source off, press and hold the MUSIC VOLUME DOWN button until the volume level goes to zero.

Adjust System Music Volume

Adjust the system music volume from any Remote Station by pressing VOLUME UP or VOLUME DOWN.

- **Select Music Source**

The system music source can be selected from any Remote Station. The music sources that are available vary depending on the Scan setting on the Master Station (See Master Station Settings/Music Settings/Scan Mode for details).

Note: You cannot select specific tracks on the CD from a Remote Station.

To scan for a music source:

Simultaneously press and release VOLUME UP and VOLUME DOWN to switch music sources.

Note: If you press and hold these buttons for 4 seconds or more, you initiate the Security/Home Automation function (See Intercom Operation/Security/Home Automation for details). This function is not available on the outdoor remote station.

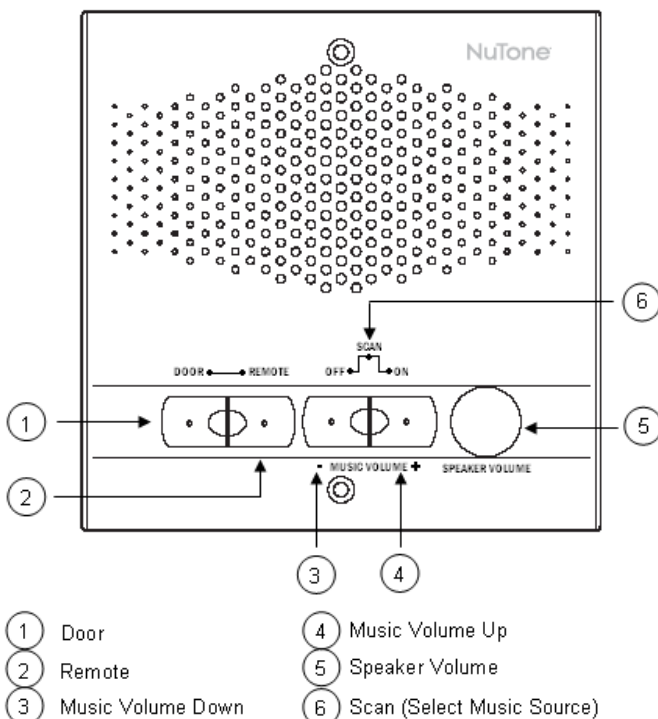

Note: If you press and hold these buttons for 4 seconds or more, you initiate the Security/Home Automation function (See Intercom Operation/Security/Home Automation for details). This function is not available on the Outdoor Remote Station.

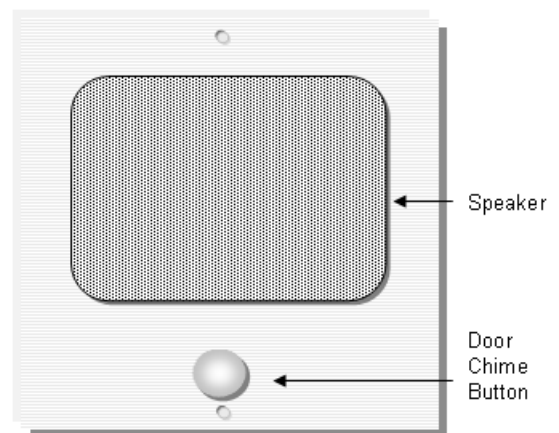

DOOR STATION FUNCTIONS

When the button on the Door Station is pressed, the chime is heard on all stations set to Intercom or Radio/INT.

- All system audio (music and intercom) is muted when the chime rings.
- If the Door Station is engaged in a talk or listen session, the chime is not heard.

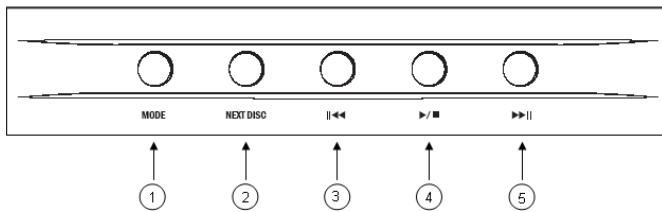
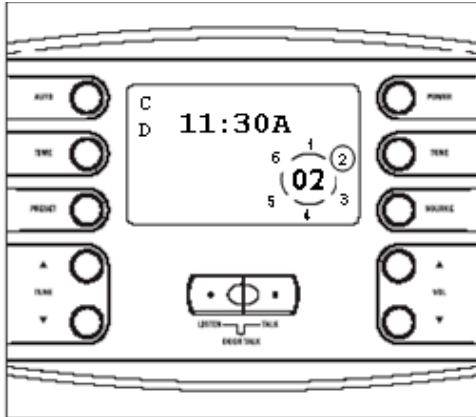

- ① Select Mode
- ② Next Disc
- ③ Previous Track
- ④ Play/Pause
- ⑤ Next Track

CD PLAYER OPERATION (OPTIONAL)

1. Load up to 6 CDs in the CD changer.
2. Press POWER to turn on music.
3. Select CD as the music source. See Master Station Settings/Music Settings/Music Source for instructions.

When CD is selected as the music source, the display shows the following information:

- Which CD is playing, indicated by a circle around the CD number.
- The track that is playing, indicated by the number on the display.

Note: Initially, the display shows six CD positions. If the CD player reaches a CD position and does not find a CD loaded at that position, that position number disappears from the display.

CD Functions

- Select Mode
 - Available modes:
 - Normal: Play CDs and tracks sequentially
 - Repeat Song: Repeat current track
 - Repeat Disc: Repeat current disc from beginning
 - Random Disc: Randomly play tracks on current disc
 - Random All: Randomly play tracks from all CDs
 - Press and hold MODE button to display total length of time and total number of tracks on current CD.
- Next Disc
 - Play the next disc. Press and hold to display elapsed time of current track. Disabled in Random All mode.
- Previous Track
 - Play previous track or restart current track. Hold to reverse through current track. Disabled in Random Disc and Random All modes.
- Play/Pause
 - Press to pause CD. Press again to play.
- Next Track
 - Play next track. Press and hold to fast forward through current track. In Random Disc mode, player selects a random track from the current disc. In Random All mode, player selects random tracks from all discs.

Two Year Limited Warranty

WARRANTY OWNER: Broan-NuTone warrants to the original consumer purchaser of its products that such products will be free from defects in materials or workmanship for a period of two (2) years from the date of original purchase. **THERE ARE NO OTHER WARRANTIES, EXPRESS OR IMPLIED, INCLUDING, BUT NOT LIMITED TO, IMPLIED WARRANTIES OF MERCHANTABILITY OR FITNESS FOR A PARTICULAR PURPOSE.**

During this two year period, Broan-NuTone will, at its option, repair or replace, without charge, any product or part which is found to be defective under normal use and service. THIS WARRANTY DOES NOT EXTEND TO FLUORESCENT LAMP STARTERS OR TUBES, FILTERS, DUCT, ROOF CAPS, WALL CAPS AND OTHER ACCESSORIES FOR DUCTING. This warranty does not cover (a) normal maintenance and service or (b) any products or parts which have been subject to misuse, negligence, accident, improper maintenance or repair (other than by Broan-NuTone), faulty installation or installation contrary to recommended installation instructions.

The duration of any implied warranty is limited to the two year period as specified for the express warranty. Some states do not allow limitation on how long an implied warranty lasts, so the above limitation may not apply to you.

BROAN-NUTONE'S OBLIGATION TO REPAIR OR REPLACE, AT BROAN-NUTONE'S OPTION, SHALL BE THE PURCHASER'S SOLE AND EXCLUSIVE REMEDY UNDER THIS WARRANTY. BROAN-NUTONE SHALL NOT BE LIABLE FOR INCIDENTAL, CONSEQUENTIAL OR SPECIAL DAMAGES ARISING OUT OF OR IN CONNECTION WITH PRODUCT USE OR PERFORMANCE. Some states do not allow the exclusion or limitation of incidental or consequential damages, so the above limitation or exclusion may not apply to you. This warranty gives you specific legal rights, and you may also have other rights, which vary from state to state. This warranty supersedes all prior warranties.

WARRANTY SERVICE: To qualify for warranty service, you must (a) notify Broan-NuTone at the address or telephone number below, (b) give the model number and part identification and (c) describe the nature of any defect in the product or part. At the time of requesting warranty service, you must present evidence of the original purchase date.

Date of Installation

Builder or Installer

Model No. and Product Description

IF YOU NEED ASSISTANCE OR SERVICE - CONTACT:

Broan-NuTone LLC Hartford, Wisconsin www.nutone.com 888-336-3948
Broan-NuTone Canada Mississauga, Ontario www.nutone.ca 877-896-1119

Rev. 08/2007

Garantie limitée de deux ans

GARANTIE DU PROPRIÉTAIRE: Broan-NuTone garantie à l'acheteur original de ses produits que ces derniers seront exempts de tout défaut de matériaux et de fabrication pour une période de deux (2) ans à compter de la date d'achat. **AUCUNE AUTRE GARANTIE, IMPLICITE OU EXPRESSE, N'EST DONNÉE, Y COMPRIS, MAIS SANS S'Y LIMITER, GARANTIE DE MARCHANDIBILITÉ OU D'ADAPTATION À UN USAGE PARTICULIER.**

Pendant cette période de deux ans, Broan-NuTone procédera au remplacement ou à la réparation sans aucuns frais, mais à sa propre discrétion, de tout produit ou pièce jugé défectueux dans le cadre d'une utilisation normale. CETTE GARANTIE NE VISE PAS LES DISPOSITIFS D'AMORCAGE NI LES TUBES DES LUMINAIRES FLUORESCENTS. Cette garantie ne couvre pas (a) l'entretien et le service courants ni (b) les produits et les pièces ayant fait l'objet d'un usage abusif, de négligence, d'un accident, d'un entretien ou d'une réparation non appropriée (par du personnel non autorisé par Broan-NuTone) d'une mauvaise installation ou d'une installation non conforme aux directives d'installation fournies.

La durée de toute garantie implicite est limitée à la période de deux ans précisée pour la garantie expresse. Certains états ne reconnaissent pas les restrictions relatives à la durée des garanties implicites; il se pourrait donc que cette restriction ne s'applique pas dans votre cas.

LE REMPLACEMENT OU LA RÉPARATION PAR BROAN-NUTONE, À SA PROPRE DISCRÉTION, DE TOUT PRODUIT OU PIÈCE DÉFECTUEUX CONSTITUE LE SEUL REMÈDE DE L'ACHETEUR EN VERTU DE CETTE GARANTIE. BROAN-NUTONE NE PEUT ÊTRE TENUE RESPONSABLE DES DOMMAGES INDIRECTS, CONSÉCUTIFS OU SPÉCIAUX ATTRIBUABLES À UTILISATION OU AU RENDEMENT DU PRODUIT. Certains états ne reconnaissent pas les restrictions ni les exclusions relatives aux dommages indirects, consécutifs ou spéciaux; il se pourrait donc que cette restriction ne s'applique pas dans votre cas. La présente garantie vous accorde des droits spécifiques, mais vous pourriez aussi avoir d'autres droits en fonction de l'état dans lequel vous résidez. Cette garantie remplace toute autre garantie donnée précédemment.

SERVICE SOUS GARANTIE: Pour être admissible au service sous garantie, vous devez (a) aviser Broan-NuTone, à l'adresse ou au numéro de téléphone ci-dessous, (b) fournir le numéro du modèle et la description de la pièce et (c) décrire la nature défaut de la pièce ou du produit. Au moment de la demande de service sous garantie, vous devez fournir une preuve de la date d'achat originale.

Date d'installation

Entrepreneur ou installateur

N° de modèle et description du produit

POUR OBTENIR DE L'ASSISTANCE OU DU SERVICE - CONTACTEZ:

Broan-NuTone LLC Hartford, Wisconsin www.nutone.com 888-336-3948
Broan-NuTone Canada Mississauga, Ontario www.nutone.ca 877-896-1119

Rev. 08/2007

Garantía limitada de dos años

GARANTÍA DEL PROPIETARIO: Broan-NuTone garantiza al comprador consumidor original de sus productos, por el período de dos (2) años desde la fecha original de compra, que tales productos están libres de defectos en material y mano de obra. **NO HAY OTRAS GARANTÍAS, EXPRESADAS O SOBREENTENDIDAS, INCLUYENDO, PERO NO LIMITADAS A, GARANTÍAS NO EXPRESADAS DE MARCHANDIBILIDAD O ADAPTABLES A UN PROPÓSITO EN PARTICULAR.**

Durante este período de dos años, Broan-NuTone reparará o reemplazará a su opción y sin costo, cualquier producto o parte que se encuentre defectuoso bajo condiciones normales de uso y servicio. ESTA GARANTÍA NO CUBRE A LOS ARRANCADORES PARA LÁMPARAS FLUORESCENTES O A LOS TUBOS FLUORESCENTES, FILTROS, DUCTOS, TAPAS DE TECHO, TAPAS DE PARED Y OTROS ACCESORIOS PARA CANALIZACIÓN. Esta garantía no cubre (a) Mantenimiento y servicios normales (b) Productos o partes sujetos al mal uso, negligencia, accidente, mantenimiento inadecuado o reparaciones (por otros ajenos a Broan-NuTone), instalación defectuosa o a una instalación contraria a las instrucciones de instalación recomendadas.

La duración de cualquier garantía no expresada está limitada a un período de dos años según se especifica en la garantía expresada. Algunos estados no permiten limitación en cuanto a la duración de una garantía no expresada, por lo que la limitación arriba indicada puede que no se aplique a Ud.

LA OBLIGACIÓN DE BROAN-NUTONE DE REPARAR O REEMPLAZAR A SU OPCIÓN, SERÁ EL ÚNICO Y EXCLUSIVO RECURSO QUE TENDRÁ EL COMPRADOR BAJO ESTA GARANTÍA. BROAN-NUTONE NO SERÁ RESPONSABLE POR DAÑOS INCIDENTALES, CONSECUTIVOS O ESPECIALES QUE RESULTEN A CONSECUENCIA O SEAN INDEPENDIENTE DEL USO O DESEMPEÑO DEL PRODUCTO. Algunos estados no permiten la exclusión o limitación de daños incidentales o consecuentes, de modo que la limitación o exclusión arriba indicada pueda que no se aplique a Ud. Esta garantía le proporciona derechos legales específicos, y Ud. puede tener otros derechos, los cuales varían de estado a estado. Esta garantía reemplaza a todas las garantías anteriores.

SERVICIO DE GARANTÍA: Para tener derecho al servicio de garantía, Ud. debe (a) Notificar a Broan-NuTone a la dirección o el número de teléfono abajo, (b) indicar el número de modelo y la identificación de la party y (c) describir la naturaleza de cualquier defecto en el producto o parte. Al momento de solicitar el servicio por la garantía, Ud. debe presentar la evidencia de la fecha original de compra.

Fecha de la instalación

Constructor o instalador

Número de modelo y descripción del producto

SI NECESITA ASISTENCIA O SERVICIO - CONTACTO:

Broan-NuTone LLC Hartford, Wisconsin www.nutone.com 888-336-3948
Broan-NuTone Canada Mississauga, Ontario www.nutone.ca 877-896-1119

Rev. 08/2007