

Intrasonic Technology, Inc.

Color Video Door Phone / Intercom

Installation Manual

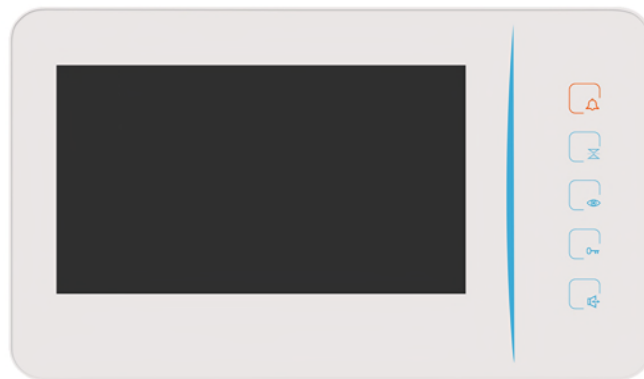



**TABLE OF CONTENTS:**

|                                                 |      |
|-------------------------------------------------|------|
| Cover Page                                      | 1    |
| Table of Contents                               | 2    |
| Safety Instructions                             | 3    |
| Power Supply                                    | 4    |
| General Wiring Requirements                     | 5    |
| Connections on Rear of Door Camera              | 6    |
| Connections for Optional Door Release Mechanism | 6    |
| System Wiring (Daisy Chain)                     | 7    |
| Preparing Components for Installation           | 8    |
| Installing the Door Station                     | 9-10 |
| Installing the Room Monitor                     | 11   |
| Additional Safety Instructions                  | 12   |



**SAFETY INSTRUCTIONS:**

- ❑ To reduce the risk of electrical shock, this video door phone system must be installed by a qualified installer or dealer.
- ❑ Please read the instruction manual in it's entirety before installing.
- ❑ The apparatus shall not be exposed to dripping or splashing from liquids. No objects filled with liquids, such as vases shall be placed on or near the apparatus.

**Do's and Don'ts:**

**Don'ts**

- ✓ Expose any parts of the system to moisture.
- ✓ Locate the inside monitors back to back or on walls facing each other. This can cause system feedback.
- ✓ Keep inside stations at least 10 feet apart to prevent feedback.
- ✓ Keep all video door phone wiring away from all other wiring in the walls. Wires too close can cause hum.
- ✓ Use with unapproved products.
- ✓ Staple wires and cables or use wire splices
- ✓ Install video door phone wires near dimmer controls or florescent light lines or fixtures. Keep wiring and stations at least 18 inches from any AC wiring. This can cause humming or buzzing noises in the system.

**Do's**

- ✓ Install by a qualified installer or dealer
- ✓ Use only approved products with the video door phone system
- ✓ If using the separate power supply, use a dedicated power line to the supply. Not having a dedicated line could result in humming or buzzing noises in the system.
- ✓ Locate stations away from any heat sources.
- ✓ Label all cable runs.

**POWER SUPPLY:**

There are two power supply options. The first is the local plug in supply (wall wart) that is plugged into an available outlet at each monitor station. This power supply is provided with each monitor station. The supply simply plugs into the monitor with the adapter plug provided.



← Plug in power supply

The second is the optional remote mounted power supply. This power supply can be mounted in a closet or some other remote location that is out of sight. With this option there would be no wires coming from the monitor to an external power supply. This supply can power up to 4 monitors and 4 door stations. The wires from the power supply to each monitor, can be run inside the wall cavity so there are no exposed wires.



← Remote mounted power supply

**GENERAL WIRING REQUIREMENTS:**

A wiring harness is provided. Its length is about 35 feet. If you need a longer cable, use a 4 conductor, 20 AWG (minimum) size wire. The total system from the first monitor to the last camera should not exceed 400 feet. Exceeding this length may cause performance issues.

Wiring from the remote power supply to the monitors shall be 18 AWG (minimum) 2 conductor wire. Power from the power supply, needs to be run to **each** monitor. Cameras **do not** require power from the power supply.

Cameras need to be installed at normal eye height. Approximately between 60 and 68 inches high.

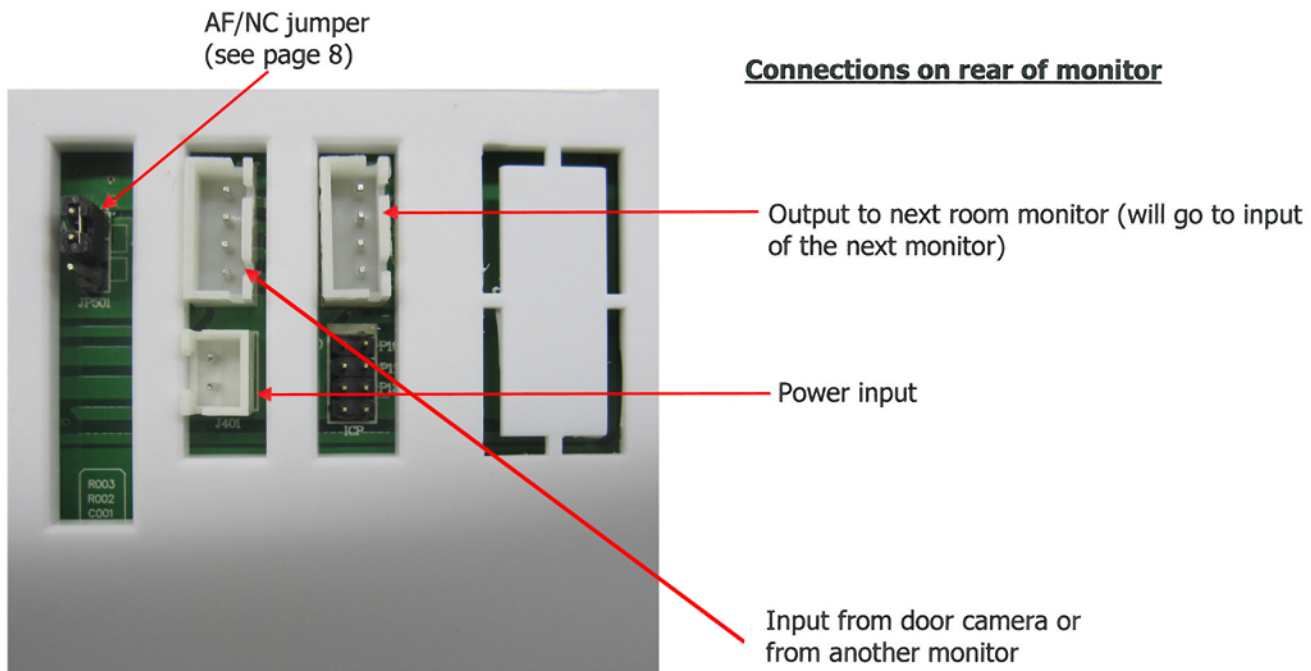

When installing more than one monitor, the monitors are "daisy chained" together. In other words, the output from one monitor is wired to the input of the next monitor. This is the same procedure for all monitors up to a maximum of 4 monitors per system.

**If you are not using the cable provided**

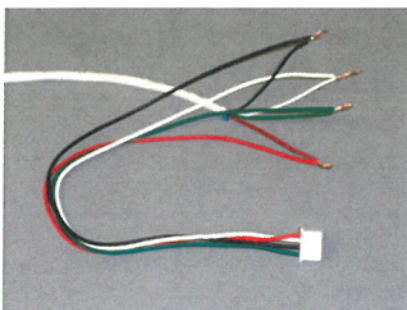

Connectors with lead wires are provided for both monitor/camera connections and for power connections. Connect these leads to a 4 conductor cable for the monitor/camera connection as shown. Make sure the connections are the same on both ends. Pin 1 on the connector needs to be wired to the same pin 1 on the other end of the cable. Once secure cover the connections with small wire nuts or shrink tubing to prevent the connections from touching each other or any other metal object. Power leads are connected the same way using the 2 conductor connectors to 2 conductor wire. This is only for the remote mounted power supply.. Be sure to connect the power supply Positive (+) lead to the (+) terminal on the monitor's printed circuit board. When installing the plug in power supply

(wall wart), use the plug in adapter cable provided.

Intrasonic Technology, Inc. 9525 Forest View Street Dallas Texas 877-435-0670  
[www.intrasonictechnology.com](http://www.intrasonictechnology.com)

## Connections on rear of the door camera

Lock 2 is not used, for European installations only

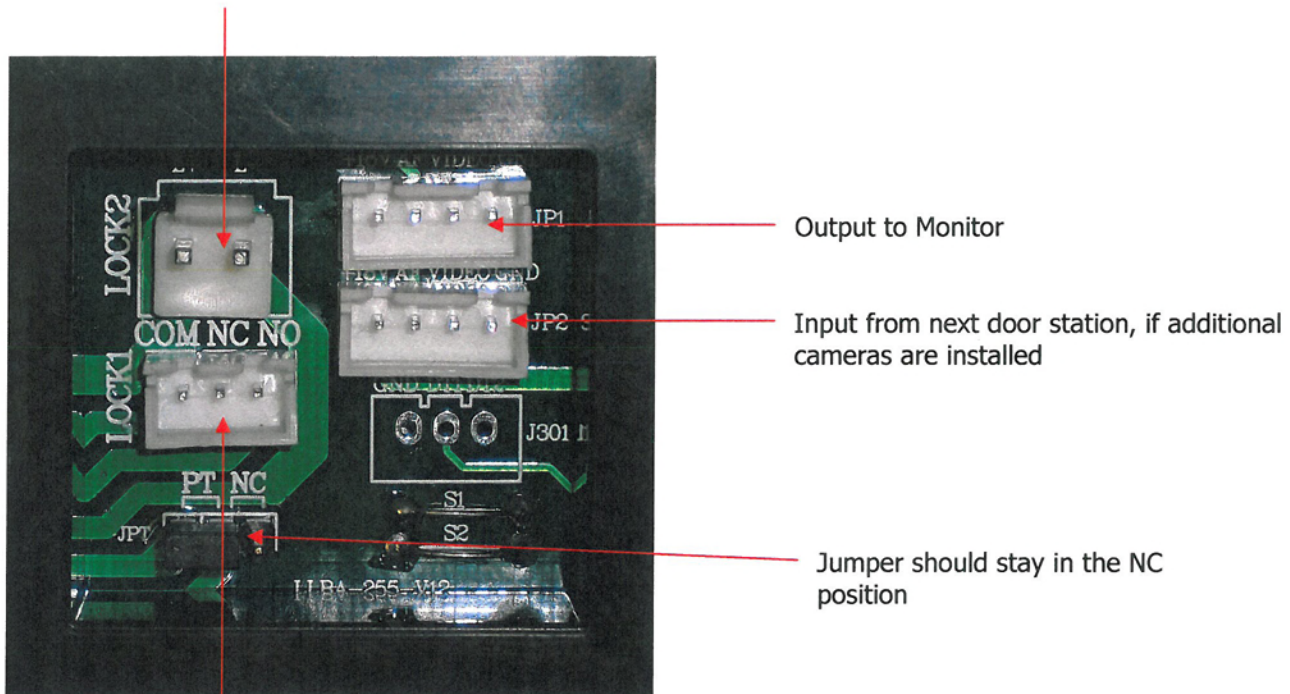

Connections for door unlock option

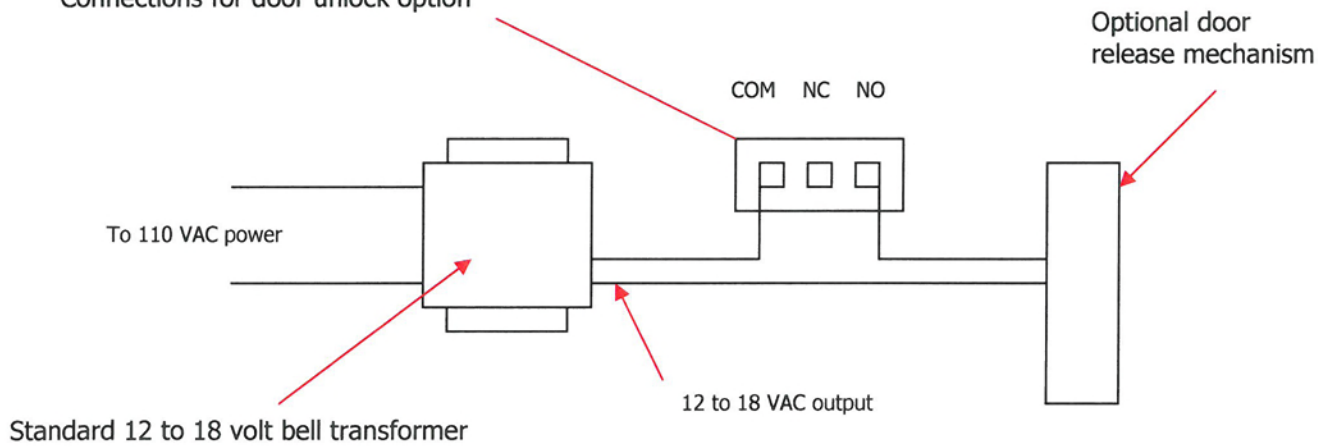

Note: See page 8 for configuration of Jumpers S1 & S2

**System Wiring:**

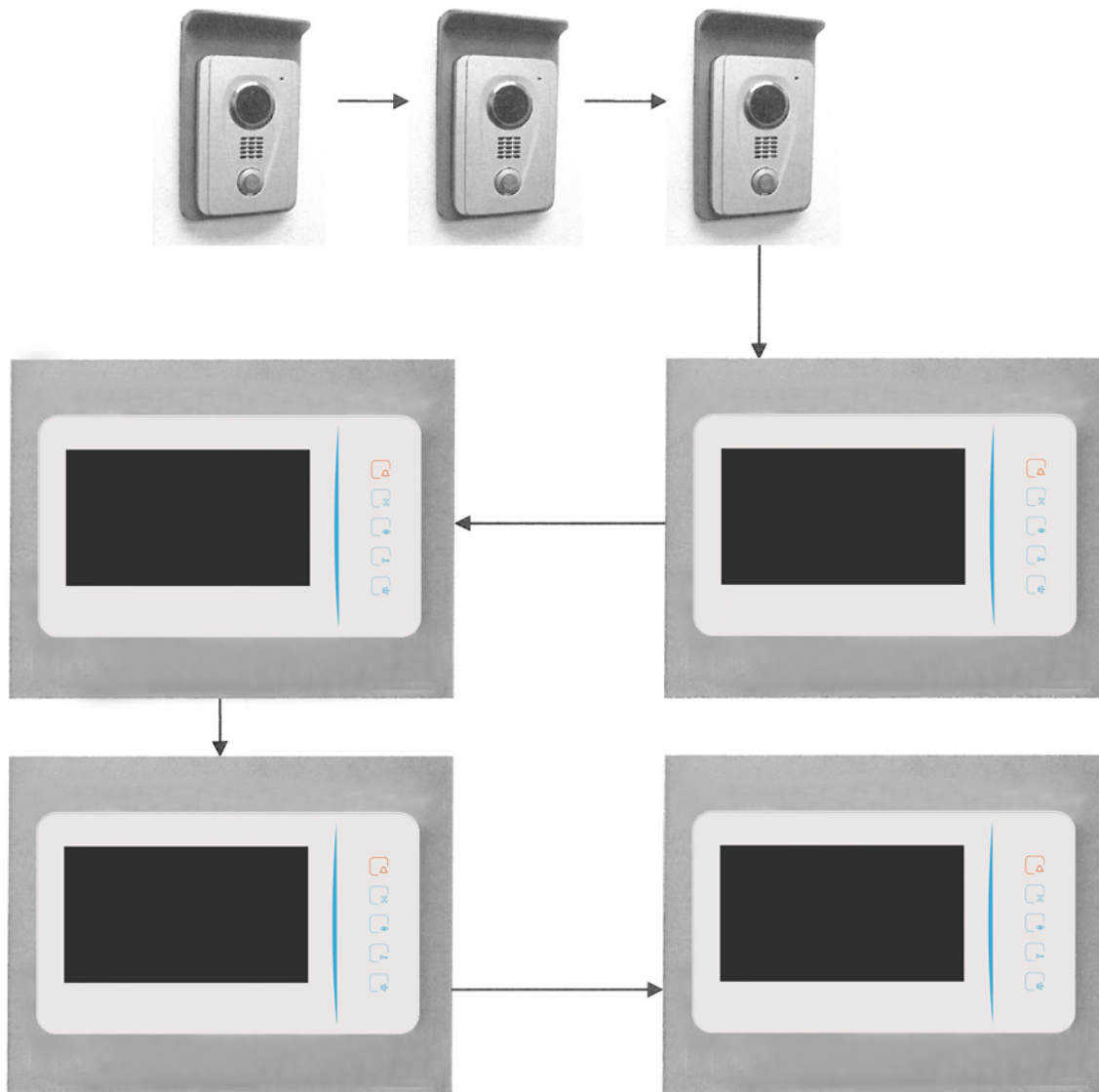

The stations are wired in series or "daisy chained" together. The output of one station goes to the input of the next station. This is done with a 4 conductor cable. Power needs to be supplied to each monitor with either the wall plug-in adapter (provided) or the optional Remote mounted power supply.

**IMPORTANT NOTE:**

There is a 75 ohm resistor provided in the kit. This resistor needs to go across the black and green wires of the last monitor in the daisy chain. The last monitor is the one with no connection to the output side. In the example above this would be the monitor on the bottom right. In the case where there is only one monitor, this resistor is not required.

**PREPARING THE COMPONENTS FOR INSTALLATION:**

To set the system up for multiple door stations you must first determine how many door station cameras (1-4) the system will have. If you are installing more than one door station, there are jumpers on the back of the door stations that will need to be cut. The number of jumpers and which jumpers that need to be cut, depends on how many door stations you will be installing.

**For one door station you do not need to cut any jumpers.**

Follow the chart below to determine which jumpers need to be cut;

| <u>Number of Door Stations</u> | <u>Jumper S1</u> | <u>Jumper S2</u> |
|--------------------------------|------------------|------------------|
| If you have 1 door station     | do not cut       | do not cut       |
| If you have 2 door stations    |                  |                  |
| 1 <sup>st</sup> door station   | do not cut       | do not cut       |
| 2 <sup>nd</sup> door station   | <b>cut</b>       | do not cut       |
| If you have 3 door stations    |                  |                  |
| 1 <sup>st</sup> door station   | do not cut       | do not cut       |
| 2 <sup>nd</sup> door station   | <b>cut</b>       | do not cut       |
| 3 <sup>rd</sup> door station   | do not cut       | <b>cut</b>       |
| If you have 4 door stations    |                  |                  |
| 1 <sup>st</sup> door station   | do not cut       | do not cut       |
| 2 <sup>nd</sup> door station   | <b>cut</b>       | do not cut       |
| 3 <sup>rd</sup> door station   | do not cut       | <b>cut</b>       |
| 4 <sup>th</sup> door station   | <b>cut</b>       | <b>cut</b>       |

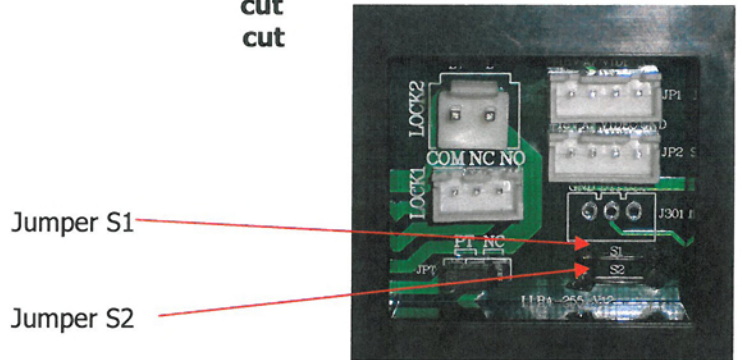

To setup the system for room monitors, you must first determine the number of monitors (1-4) the system will have. If you are installing more than one room monitor, you will need to switch the jumper on the back of the monitors as noted below. This jumper has two positions. Either AF or NC. Monitors should arrive with the jumper in the AF position.

- 1 Monitor = Leave jumper in AF position
- 2 or more monitors = Change jumper position to NC for all monitors except one leave in the AF position. In other words if you have 3 monitors in the system, 2 of them need to be in the NC position and the third one in the AF position. It does not make any difference which monitors are switched to NC, as long as two of the three are switched.



**INSTALLING THE DOOR STATION:**

The kit shown below is supplied with each door station.

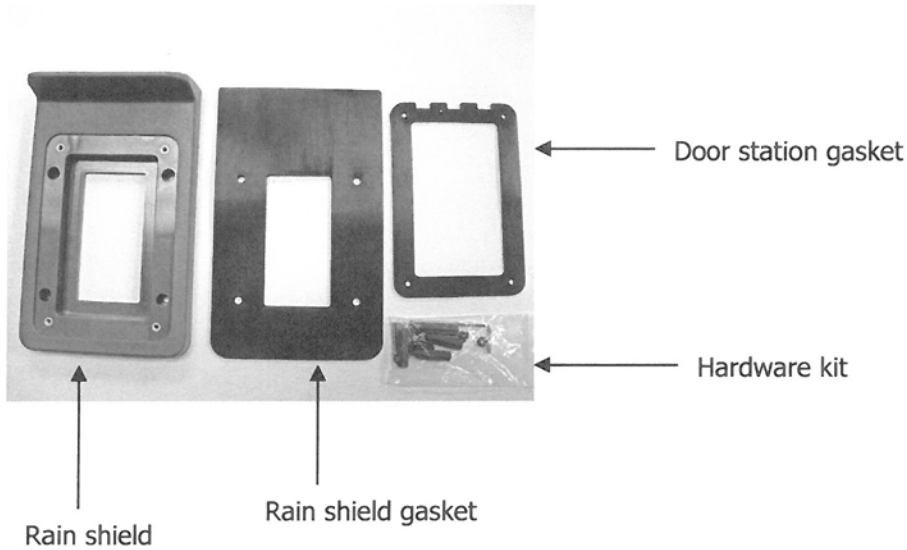

Select a height for the door station where the camera is positioned approximately eye high for the visitor. Using the rain shield as a template, mark the 4 mounting hole locations on the wall and the large square hole location on the wall. In the large square you will need to drill a hole to bring the wires from inside the wall into the door station. In the 4 mounting hole locations, place 4 anchoring devices suitable for the specific wall material.

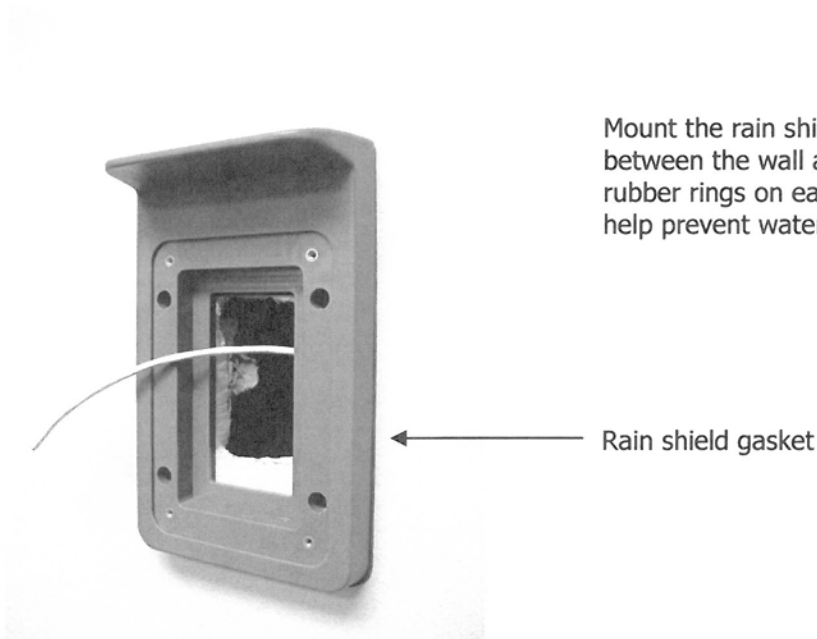

Mount the rain shield to the wall with the rain shield gasket between the wall and the plastic rain shield. Place one of the rubber rings on each screw before installing the screw. These help prevent water leakage getting behind the camera.

Using the allen wrench provided, remove the screws on the top and bottom of the door station. This allows you to remove the door station cover. Next wire the provided 4 conductor cable connector to the end of the 4 conductor cable in the wall. See General Wiring Requirements on Page 5. (If you are using the cable provided, you can skip the last step.) Plug the cable into the input jack JP1 on the back of the door station. If there is a second door station, the cable from this station plugs into JP2. Insert the door station gasket as shown. Review General Wiring Requirements.

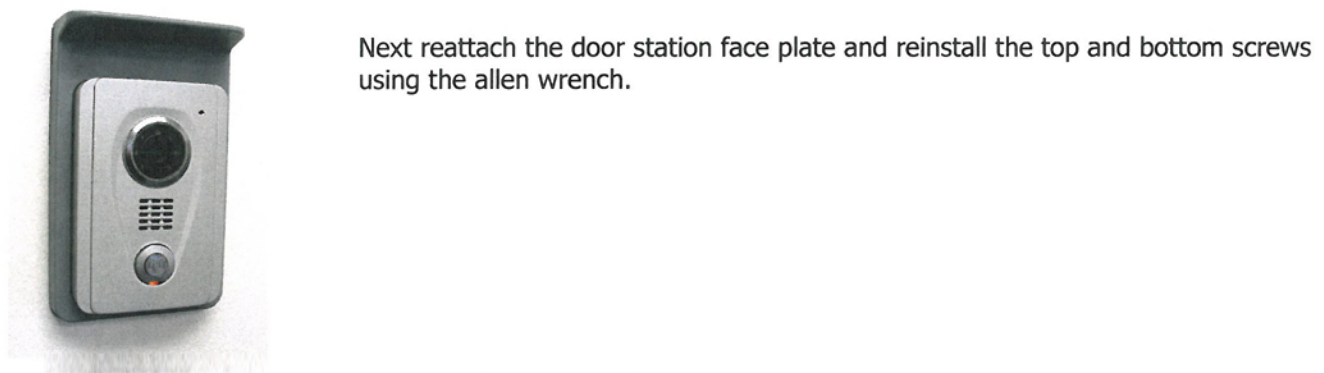
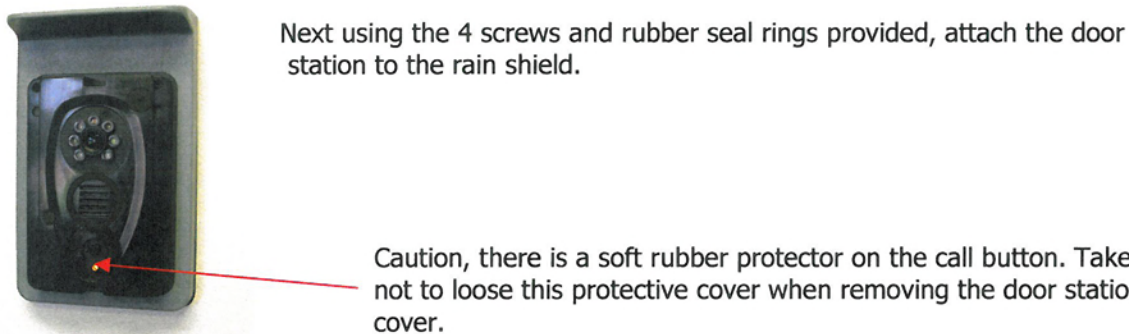
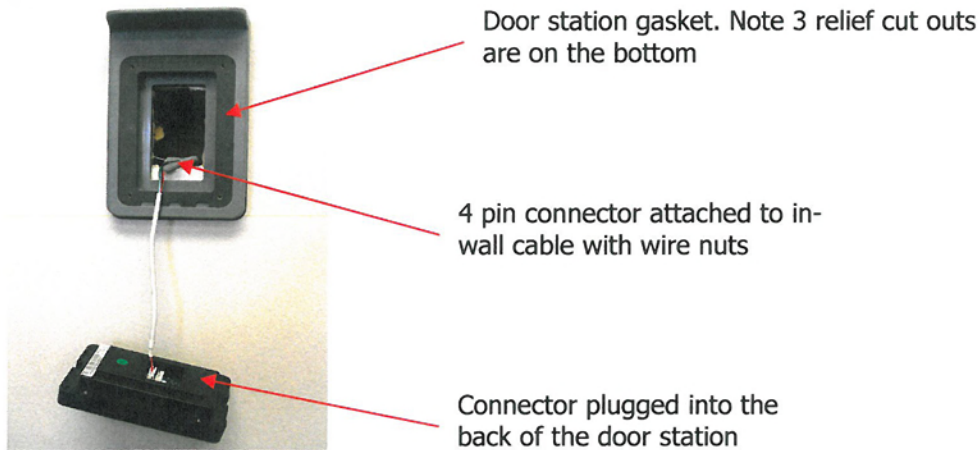

### **Installing the room Monitor:**

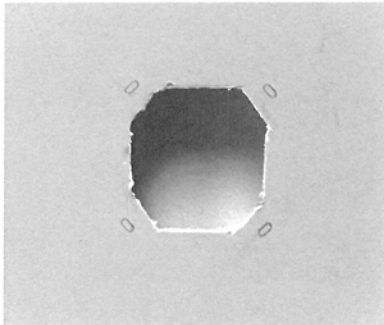

Cut a hole in the wall for the mounting bracket. The hole should be approximately 3 inches by 3 inches. Do NOT cut a rectangular hole as mounting holes are in the corners. Cut the corners at an angle as shown to allow for the mounting holes.

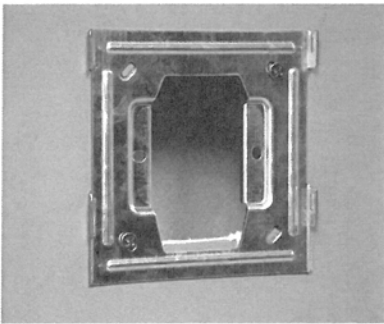

Using the anchors and screws provided for sheetrock or other suitable anchors, mount the monitor holding bracket to the wall. Be sure the 4 metal tabs are facing up so the monitor can slide down on these tabs when installing. Tighten all 4 corners to the wall and make sure the back of the bracket is flush against the wall.

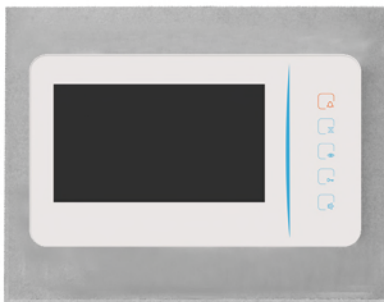

Bring the wire out of the hole and plug it into the appropriate jack on the rear of the monitor. Input cables from a camera or another monitor go into the center connector (IN). If there is a second cable for output to another monitor, it should be plugged into the connector on the right (OUT).

If you are using the wall plug-in power supply, it will need to be plugged into the 2 pin connector on the left using the adapter provided.

If you have prewired for the optional remote mounted power supply, then the 2 leads from this power supply will need to be wired to the 2 pin adapter provided (with red & black leads) and the adapter plugged into the 2 pin connector on the left.

(see general wiring requirements on page 5)

## Safety

Please read all instructions carefully before operating the system.

- A Read these instructions.
- B Keep these instructions.
- C Heed all warnings.
- D Follow all instructions.
- E Do not use this apparatus near water.
- F Clean only with a dry cloth.
- G Do not block any ventilation openings, and install in accordance with the manufacturers instructions.
- H Only use attachments and accessories specified by the manufacturer.
- I Do not expose to moisture. This can cause shock hazards or create fire and void the warranty.
- J Do not service this product yourself. Attempting to service this product may expose you to high voltage and will void the warranty. Please contact a qualified local dealer for service.
- K Any substitutions of non-Intrasonic Technology products may result in electrical shock or other hazards.
- L The apparatus should not be exposed to dropping or splashing of liquids. No objects filled with liquids, such as vases, should be placed on the apparatus.

**WARNING:** To reduce the risk of fire or electric shock, do not expose this apparatus to rain or moisture.



**AVERTISSEMENT:** POUR ÉVITER LE RISQUE D'INCENDIE OU DE CHOCS ÉLECTRIQUES, NE PAS EXPOSER CET APPAREIL À LA PLUIE OU À L'HUMIDITÉ

**CAUTION** - TO REDUCE THE RISK OF ELECTRIC SHOCK, DO NOT REMOVE COVER (OR BACK). NO USER-SERVICEABLE PARTS INSIDE. REFER TO QUALIFIED SERVICE PERSONNEL.

**ATTENTION** - POUR RÉDUIRE LE RISQUE DE CHOC ÉLECTRIQUE, NE PAS RETIRER LE COUVERCLE (OU L'ARRIÈRE). NON UTILISATEUR À L'INTÉRIEUR. VOIR À UN PERSONNEL QUALIFIÉ.

## FCC

This device complies with Part 15 of the FCC rules. Operation is subject to the following two conditions; (1) this device may not cause harmful interference, (2) this device must accept any interference received, including interference that may cause undesirable operation.

Warning: Changes or modifications to this unit not expressly approved by the party responsible for compliance could void the users authority to operate the equipment.

Note: This equipment has been tested and found to comply with the limits for a Class B digital device, pursuant to Part 15 of the FCC rules. These limits are designed to provide reasonable protection against harmful interference in a residential installation. This equipment generates, uses, and can radiate radio frequency energy and, if not installed and used in accordance with the instructions, may cause harmful interference to radio communications. However, there is no guarantee that interference will not occur in a particular installation. If this equipment does cause harmful interference to radio or television reception, which can be determined by turning the equipment on and off, the user is encouraged to try to correct the interference by one or more of the following measures;

- Reorient or relocate the receiving antenna.
- Increase the separation between the equipment and the receiver.
- Connect the equipment into an outlet on a circuit different from which the receiver is connected.
- Consult with the dealer or an experienced radio technician for help.