

Installation Instructions

Rough-In

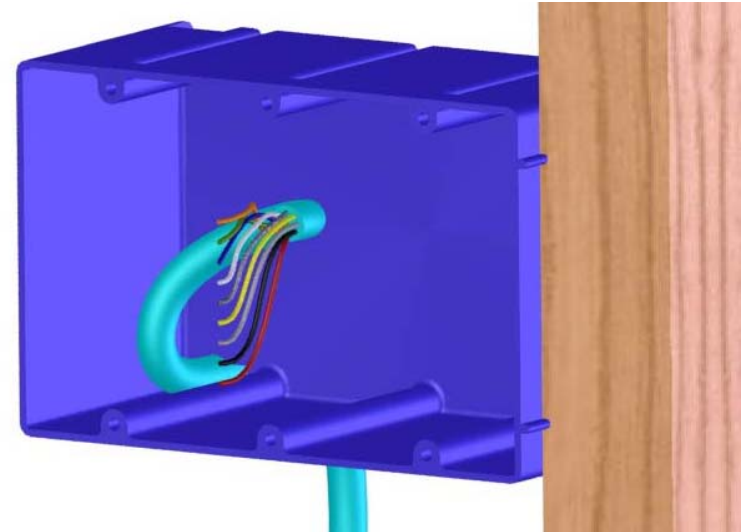

Illustration 1

Step 1: Attach a composite 3-gang electrical box to a wall stud at desired location for System One MINI. Run Valet intercom cable (8VM500) or Cat5 cable to all installed room station locations. (Illustration 1 shows a typical rough-in configuration.) Valet System One intercoms can be wired in a loop or star style configuration. Star configuration is also referred to as "home run". If the "home run" style of wiring is desired, we recommend utilizing a structured wiring enclosure with RJ45 style connectors for a hassle free installation. Attach VMT50 Transformer and PBDC15 Power Supply the same way as indicated in the Original System One Installation Manual which is included with the Power Supply.

Inventory

System One Mini Carton Contents

Included with the System One Mini box you will find the following items:

- 1 - System One MINI Room Station
- 1 - System One MINI Metal Mounting Bracket
- 2 - Plastic End Tabs
- 4 - #6 x 7/8" Phillips Head Screws (In plastic bag with #6 washers)
- 4 - #6 Flat Washers (In plastic bag with #6 screws)
- 4 - #4 x 3/8" Phillips Head Screws (Pre-installed in Metal Bracket)
- 1 - Terminal Block (In plastic bag)
- 1 - 220k Load Resistor



P.O. Box 1708
Ponca City, OK 74602
580-762-2457
Toll Free: 1-800-546-3729
www.valetsystems.com

All rights reserved. No part of this publication may be reproduced or transmitted in any form or by any means without written consent. Valet® is a registered trademark of Lindsay Manufacturing, Inc.

Finish Out

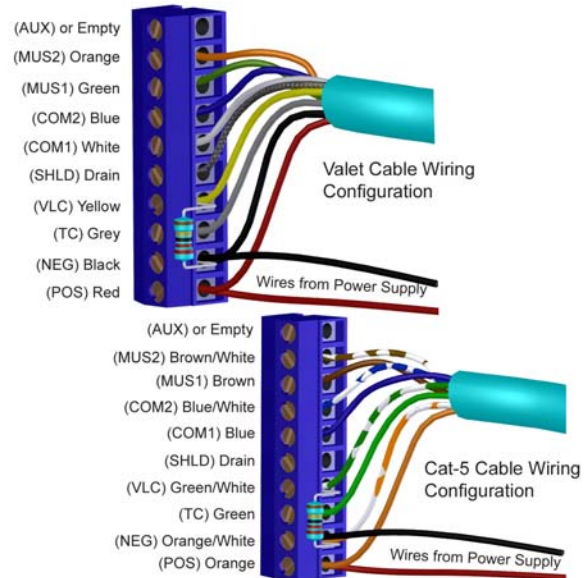
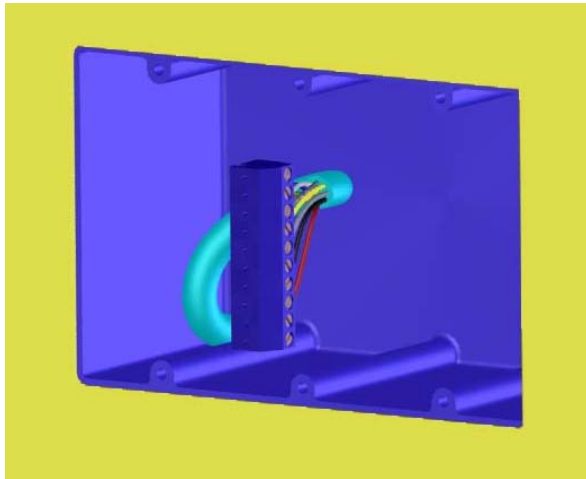

Illustration 2

Step 1: At finish out time, the first step to installing a System One MINI room station is to install the terminal block. The terminal block must be wired as show in Illustration 2 above. Wiring configurations for Valet Cable and Cat5 Cable have both been provided. Also shown in the illustration above is the proper location to install the 220K resistor. Only one resistor will need to be installed for the system and it is recommended that the resistor is installed at the station that has the power supply connected to it.

System One Operation

This new System One MINI room station functions exactly like the full size Original System One room station. Please refer to the Original System One Operators Manual for proper operation.

Room Station Identification Chart

Room Station Number	Room in the house that the System One Station is located

Finish Out - (Continued)

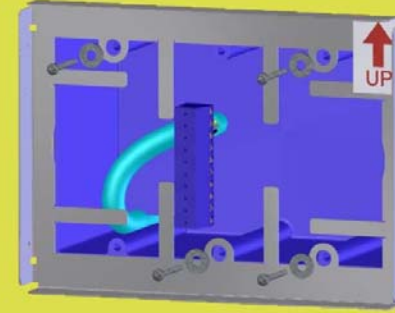

Illustration 3

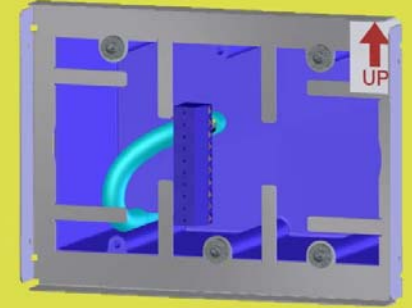

Illustration 4

Step 2: The next step is to mount the metal bracket to the 3-gang box. The metal bracket can only be installed one way. There is a red "UP" arrow in the upper right hand corner of the bracket that indicates which way the bracket is to be installed. The metal mounting bracket is to be secured to the 3-gang box by the four #6 x 7/8" screws each with a #6 washer behind the screw. This allows for 1/16" adjustment for proper leveling. (Illustration 3 and 4 above show how the metal mounting bracket is installed onto a 3-gang electrical box.)

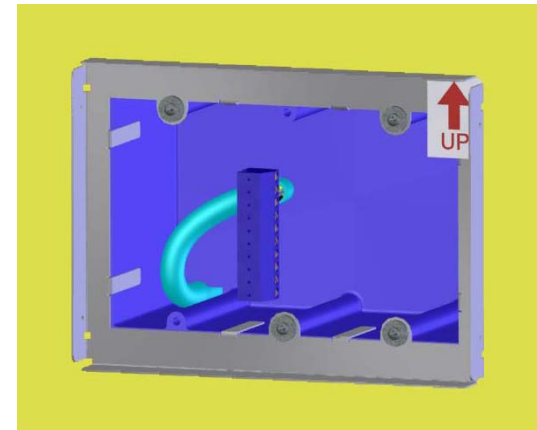

Illustration 5

Step 3: The metal mounting bracket has 8 tabs along the interior perimeter of the bracket. Once the bracket has been securely fastened to the 3-gang box, these 8 tabs will need to be bent 90° into the 3-gang box opening, (as shown in Illustration 5 above). These tabs are for use in a retro-fit application.

Finish Out - (Continued)

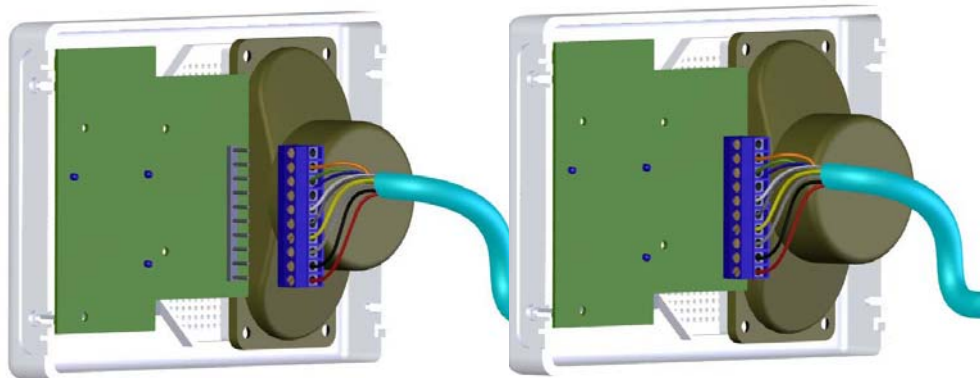

Illustration 6

Illustration 7

Step 4: The Terminal Block can now be connected to the 10 pin strip located on the back of the PC Board. The Terminal Block must be connected exactly as shown in Illustration 6 and Illustration 7 above. If using Valet cable, the Red wire should be on the bottom connector of the 10 pin strip. Keep in mind, if using Cat5 cable, the Orange wire should be on the bottom connector of the 10 pin strip. In both instances the screws that secure the wires into the Terminal Block must be facing away from the speaker.

Finish Out - (Continued)



Illustration 10

Illustration 11

Step 6: Once the fascia is flush against the wall, the screws that are already installed in the metal mounting bracket will need to be tightened to hold the fascia in place. After securing the fascia to the mounting bracket, the end tabs that cover up the screws will need to be snapped onto the ends of the fascia. These steps are shown in Illustration 10 and Illustration 11 above.



Illustration 8

Illustration 9

Step 5: Once the Terminal Block is properly installed on the back of the PC Board, the room station can be mounted to the wall. Attaching the System One MINI to the mounting bracket is very easy. You simply slide the room station over the metal bracket until the back of the fascia is flush with the face of the wall as shown in Illustration 8 and Illustration 9 above.

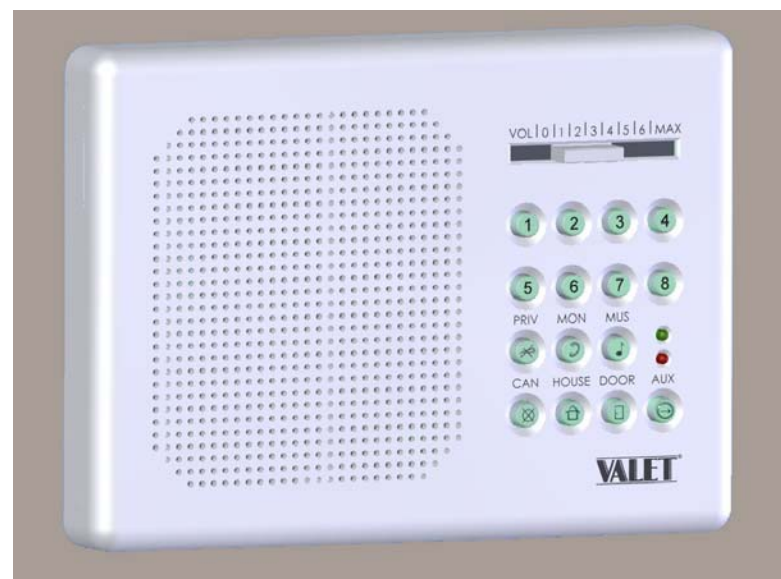

Newly Installed System One MINI Room Station